

**Elcometer 138**

**Conductivity Meter**

**Operating Instructions**



**CE** This product meets the Electromagnetic Compatibility Directive.

The product is Class B, Group 1 ISM equipment according to CISPR 11

Group 1 ISM product: A product in which there is intentionally generated and/or used conductively coupled radio-frequency energy which is necessary for the internal functioning of the equipment itself.

Class B product are suitable for use in domestic establishments and in establishments directly connected to a low voltage power supply network which supplies buildings used for domestic purposes.

elcometer® is a registered trademark of Elcometer Limited.

All other trademarks acknowledged.

Material Safety Data Sheets for the Elcometer 138 Calibration Standard Solutions are available to download via our website:

1.41 mS/cm Calibration Solution:

[www.elcometer.com/images/MSDS/elcometer\\_138\\_b771\\_calibration\\_solution.pdf](http://www.elcometer.com/images/MSDS/elcometer_138_b771_calibration_solution.pdf).

12.9 mS/cm Calibration Solution:

[www.elcometer.com/images/MSDS/elcometer\\_138\\_calibration\\_solution\\_12\\_9.pdf](http://www.elcometer.com/images/MSDS/elcometer_138_calibration_solution_12_9.pdf)

© Copyright Elcometer Limited. 2013.

All rights reserved. No part of this Document may be reproduced, transmitted, transcribed, stored (in a retrieval system or otherwise) or translated into any language, in any form or by any means (electronic, mechanical, magnetic, optical, manual or otherwise) without the prior written permission of Elcometer Limited.

A copy of this Instruction Manual is available for download on our Website via [www.elcometer.com](http://www.elcometer.com)

## CONTENTS

---

<b>Section</b>	<b>Page</b>
<b>1 About your gauge</b> .....	<b>2</b>
<b>2 Controls and display</b> .....	<b>4</b>
<b>3 Handling Precautions</b> .....	<b>6</b>
<b>4 Calibration</b> .....	<b>10</b>
<b>5 Measurement</b> .....	<b>14</b>
<b>6 Special setting mode</b> .....	<b>19</b>
<b>7 Maintenance</b> .....	<b>26</b>
<b>8 Storage</b> .....	<b>26</b>
<b>9 Technical specification</b> .....	<b>27</b>
<b>10 Spare parts and accessories</b> .....	<b>28</b>
<b>11 Related equipment</b> .....	<b>29</b>

Thank you for your purchase of this Elcometer 138 Conductivity Meter. Welcome to Elcometer.

Elcometer are world leaders in the design, manufacture and supply of inspection equipment for coatings and concrete. Our products cover all aspects of coating inspection, from development through application to post application inspection.

Your Elcometer 138 Conductivity Meter is a world beating product. With the purchase of this product you now have access to the worldwide service and support network of Elcometer. For more information visit our website at [www.elcometer.com](http://www.elcometer.com)

## **1 ABOUT YOUR GAUGE**

---

The Elcometer 138 Conductivity Meter enables accurate measurement of conductivity from a single drop sample. The Elcometer 138 Conductivity Meter can display converted concentration values and converted Total Dissolved Solids (TDS) as well as conductivity values.

The Elcometer 138 Conductivity Meter can be used to measure the conductivity of soluble salt samples in accordance with:

- ISO 8502-6/ISO 8502-9
- US NAVY PPI 63101-000 (Rev 10)

The Elcometer 138 Conductivity Meter can also be used in accordance with ISO 8502-11; AS 3894.6-A and SSPC Guide 15.

For IMO PSPC<sup>a</sup>, the surface salts should be measured and recorded. Your Elcometer 138 Conductivity Meter can be used for this.

---

a. International Maritime Organisation, Performance Standard for Protective Coatings

These operating instructions complement the operating instructions supplied with the Elcometer 138 Bresle Patch Kit and contains additional instructions not included in the Elcometer 138 Bresle Patch Kit Operating instructions.

The Elcometer 138 Conductivity Meter measures the conductivity of aqueous solutions. The meter is **not** designed to measure solids, organic solvents, surfactant, oil, adhesive, alcohol, strong acids (pH: 0 to 2) or strong alkalis (pH: 12 to 14). **The life of the sensor will be extremely short if these substances are measured.**

### 1.1 WHAT THE BOX CONTAINS

- Elcometer 138 Conductivity Meter and Sensor
- Batteries, CR2032 lithium, 2x
- Standard calibration solution 1.41 mS/cm, 14ml
- Moistening solution, 14ml
- Operating instructions



The Elcometer 138 Conductivity Meter is packed in a cardboard and foam package. Please ensure that this packaging is disposed of in an environmentally sensitive manner. Consult your local Environmental Authority for further guidance.

**To maximise the benefits of this instrument please take some time to read these Operating Instructions. Do not hesitate to contact Elcometer or your Elcometer supplier if you have any questions.**

## 2 CONTROLS AND DISPLAY

---

The meter is operated using 3 buttons and displays readings and other information on the LCD screen.

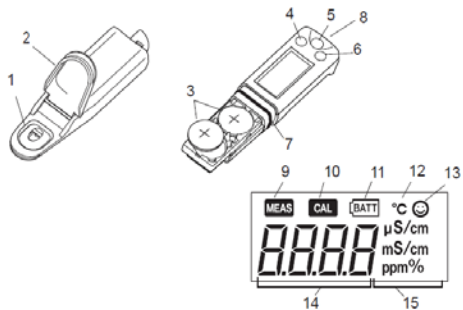

## GUIDE TO CONDUCTIVITY METER &amp; DISPLAY INDICATORS

1	<b>Measurement Cell</b>	Place a liquid sample in this cell to measure it with the electrode located on the bottom of the cell.
2	<b>Protection cover</b>	Protects the measurement cell and flat sensor in storage.
3	<b>Lithium batteries</b>	CR2032 x 2.
4	<b>MEAS button</b>	Switches the calibration mode to the measurement mode, activates/deactivates the reading locking function in the measurement mode and starts/applies settings in the special setting mode.
5	<b>ON/OFF button</b>	Turns the meter ON/OFF.
6	<b>CAL button</b>	Starts calibration and switches items/settings in the special setting mode.
7	<b>Waterproof gasket</b>	Makes the meter waterproof.
8	<b>Strap eyelet</b>	A strap can be attached here.
9	<b>MEAS icon</b>	Flashes until the measured value is stabilised and illuminates constantly when the measured value is settled, when the reading locking function is active.
10	<b>CAL icon</b>	Flashes during calibration and illuminates constantly when calibration is finished.
11	<b>Battery alarm icon</b>	Illuminates when the batteries are low and need to be replaced.
12	<b>Temperature alarm icon</b>	Flashes when the measuring environment temperature does not meet the specified operating temperature (5°C to 40°C).

13	<b>Stability icon</b>	Illuminates when measured value is stabilised.
14	<b>Measured value display</b>	Displays a measured, set and status value.
15	<b>Measurement unit display</b>	A unit symbol illuminates corresponding to the value displayed on the measured value display (14). For conductivity measurement, 'S/cm' or 'S/m' units are selectable, see 6.1 "Measurement unit setting" on page 21. For converted salt concentrations the '%' symbol illuminates and for Total Dissolved Solids (TDS) the 'ppm' symbol illuminates. The default setting is 'S/cm'.

### 3 HANDLING PRECAUTIONS

- The sensor is a consumable part. If it becomes damaged or its performance deteriorates, it will need to be replaced (the sensor is irreparable).
- To ensure the instrument is waterproof check:
  - The waterproof gasket is clean and undamaged
  - The waterproof gasket is seated properly in the groove and is not twisted or warped
- If the standard solution used for calibration of the meter comes into contact with skin, wash the skin with fresh water. If the standard solution comes into contact with eyes, immediately flush the eye with large amounts of fresh water and seek medical advice.
- Do not drop the meter.
- Never apply undue force when opening the meter (to change batteries/sensor).
- Do not exert undue force on the sensor.



- Do not allow utensils (tweezers, pipette etc.) to touch sensor cell.
- Do not measure samples hotter than 40°C (105°F).
- Do not allow contact with solvents.
- Do not subject the meter to high temperatures or humidity.
- Do not leave the meter in direct sunlight.

### 3.1 FITTING BATTERIES

The Elcometer 138 Conductivity Meter and Sensor uses dry cell batteries only. Two CR2032 lithium batteries are supplied in the kit.

To fit or replace the batteries:

1. Place batteries in the battery clips ensuring correct polarity.
2. To reassemble the meter, slide sensor onto body of the meter and push the body and the sensor together gently until the sensor retaining clip engages.

When the battery voltage becomes low, the Low Battery Warning Indicator will flash. Replace both batteries immediately.

**Note:** *Lithium batteries must be disposed of carefully to avoid environmental contamination. Please consult your local Environmental Authority for information on disposal in your region.*

**Do not dispose of any batteries in fire.**

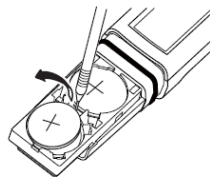
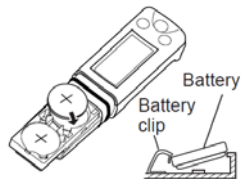

### 3.2 ATTACHING & DETACHING THE SENSOR

Turn **OFF** the meter before attaching/detaching the sensor. If the meter is turned **ON** with the sensor detached, the battery alarm may illuminate. In this case, turn the meter **OFF** and attach the sensor, and then turn the meter **ON** again.

#### Attaching the sensor:

1. Ensure that the waterproof gasket is clean and undamaged.
2. Slide the sensor across the meter so the clip fits into the hole on the sensor tongue, as shown.

**Note:** Ensure that the waterproof gasket is lying flat and not twisted.

#### Detaching the Sensor

1. Lift the sensor tongue tip and slide the sensor slightly away from the meter
2. The sensor can now be completely removed from the meter.

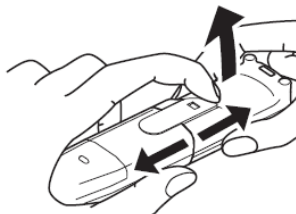
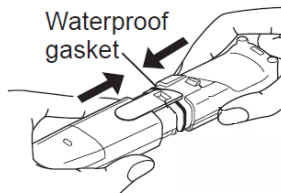

**Note:** Ensure that the sensor tongue is outside the meter case. If the tongue is inserted between the case and the connector of the meter, it may damage the connector.

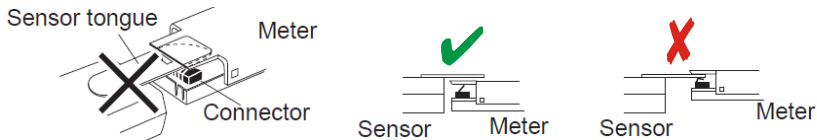

### Correct procedure for closing meter after removal of the sensor

When removing the sensor, do not let any water penetrate the inside of the meter. If some moisture remains on the waterproof gasket, very carefully wipe the moisture off.

### 3.3 SWITCHING ON/OFF

To switch on or off press the **ON/OFF** switch. When the power is turned **ON** the meter model number is displayed on the LCD.

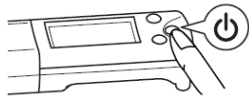

### 3.4 ELECTRODE SURFACE TREATMENT

Before using the sensor for the first time perform the electrode surface treatment as follows:

1. Put some drops of the moistening solution into the measurement cell.
2. Leave for approximately 10 minutes.
3. Clean the measurement cell with running water.
4. Wash the measurement cell with the standard solution.
5. Perform calibration.

## 4 CALIBRATION

---

### 4.1 ABOUT CALIBRATION

#### Calibration points:

The following 2-type calibrations are available:

- One-point calibration: calibration at 1.41 mS/cm
- Two-point calibration: calibration at 1.41 mS/cm and 12.9 mS/cm (solution sold separately)

One-point calibration mode is set in the instrument by default. Refer to Calibration Setting Point on page 18.

The calibration point setting and calibration result are saved after the meter is turned **OFF**.

### 4.2 PRECAUTIONS FOR CALIBRATION

- When using the sensor for the first time or again after several weeks of disuse, it is important to perform the electrode surface treatment, see Section 3.4 “Electrode surface treatment” on page 9.

- Put an appropriate amount of the standard solution or test sample into the measurement cell avoiding the inclusion of bubbles. Bubbles in the solution may cause the conductivity measurement to be inaccurate.

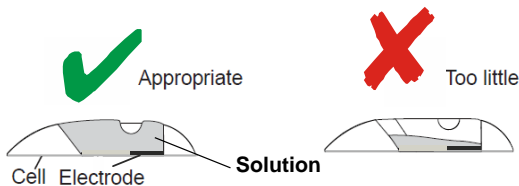

### Cross-Section of the measurement cell

- If **CAL** continues to flash and the **Err** (error message) is displayed, the calibration has failed.

Check that the standard solution conductivity is correct and perform calibration again after thoroughly cleaning the sensor.



- If the calibration failed when using the correct standard solution(s), the sensor may be damaged. Replace the sensor Part Number T13823928.
- When undertaking two-point calibration, ensure that the calibration procedures are completed respectively for 1.41 mS/cm and 12.9 mS/cm. The calibration procedure at 12.9 mS/cm cannot start until the calibration at 1.41 mS/cm has been completed and the entire calibration sequence is incomplete until the calibration at 12.9 mS/cm is achieved.

### 4.3 ONE-POINT CALIBRATION

1. To set 'One-point calibration', see 5.4 "One-Point Calibration" on page 18.
2. Open the protection cover and put some drops of the 1.41 mS/cm standard solution into the measurement cell.

Washing the sensor with standard solution beforehand may provide more accurate calibration.

3. Close the protection cover and press the CAL button for over 2 seconds.

**CAL** and ☺ flash and the calibration value is displayed

After the calibration is completed, **CAL** and ☺ flash and illuminate constantly.

4. Clean the sensor with tap water and remove moisture.
5. Press the MEAS button for 0.5 seconds to enter the measurement mode and prepare for measurement.

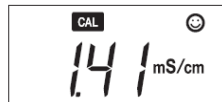
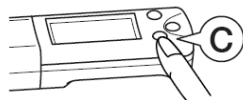

### 4.4 TWO-POINT CALIBRATION

1. To set 'Two-point calibration', see page 18.
2. Open the protection cover and put some drops of the 1.41 mS/cm standard solution into the measurement cell.

Washing the sensor with standard solution beforehand may provide more accurate calibration.

3. Close the protection cover and press the CAL button for over 2 seconds.



**CAL** and ☺ flash and the calibration value is displayed.

After the calibration is completed, **CAL** and ☺ stop flashing and illuminate constantly.

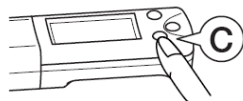

- After the calibration for 1.41 mS/cm is completed, open the protection cover and remove the 1.41 mS/cm standard solution and remove the moisture.

- Put some drops of the 12.9 mS/cm standard solution (sold separately) into the measurement cell.

Washing the sensor with standard solution beforehand may provide more accurate calibration.



- Close the protection cover and press the CAL button for over 2 seconds. **CAL** and ☺ flash and the calibration value is displayed.

After the calibration is completed, **CAL** and ☺ stop flashing and illuminate constantly.

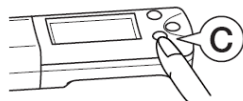

- Clean the sensor with tap water and remove moisture.

- Press the MEAS button for 0.5 seconds to enter the measurement mode and prepare for measurement.



## 5 MEASUREMENT

---

### 5.1 SAMPLE METHODS

The following sampling methods are available.

- **Drop:** for a small amount of sample - this is the preferred method for these tests.
- **Immersion:** for a large amount sample.
- **Scooping:** for sampling part of a sample.

**Note:** Although this product is waterproof, avoid immersing it completely. If the product is accidentally dropped into water, take it out of the water and remove the moisture from the instrument.

**Note:** Put an appropriate amount of the standard solution or test sample into the measurement cell avoiding the inclusion of bubbles. Bubbles in the solution may cause the conductivity measurement to be inaccurate.

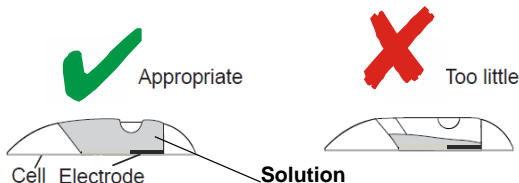

**Cross-Section of the measurement cell**



## Drop

1. Open the protection cover.
2. Put some drops of sample into the measurement cell.

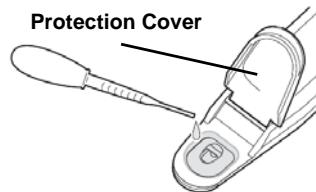

## Immersion

1. Open the protection cover.
2. Immerse the sensor into the sample and stir gently 2 or 3 times.

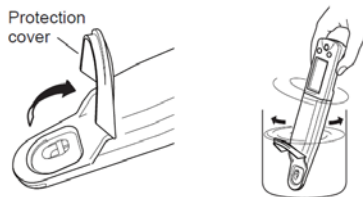

**Scooping**

1. Open the protection cover.
2. Immerse the sensor into the sample and stir gently 2 or 3 times and then scoop up some of the sample with the sensor.
3. Place the meter flat and confirm that the sample is in the measurement cell.

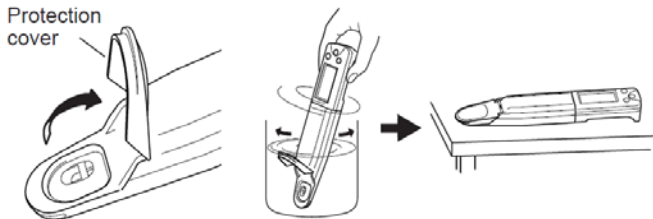
**5.2 MEASUREMENT OPERATIONS**

- **Without using the reading locking function**

1. Switch the meter on and place some drops of the sample on the sensor.
2. Read the displayed value when 😊 appears.



- **When using the reading locking function<sup>b</sup>** (*Provides a steady value in the display*)

1. Switch the meter on and place some drops of the sample on the sensor.
2. After ☺ appears, press the **MEAS** button for 0.5 seconds.

The reading locking function is activated. **MEAS** flashes until the measured value is stabilised.

When the measured value is stable **MEAS** stops flashing and the displayed value is locked with **MEAS** and ☺ illuminate constantly.



3. Read the displayed value.
4. Press the **MEAS** button for 0.5 seconds.

The reading locking function is deactivated and **MEAS** disappears.

**Note:** *If a measurement result is outside of the specified measurement range the displayed measure value flashes.*

**Note:** *Ambient air may cause the measure values to fluctuate. To reduce environmental interference close the protection cover.*

### 5.3 AFTER MEASUREMENT

1. Press the ON/OFF button to switch off meter.
  2. Wash sensor with tap water and wipe away any residual water using a clean tissue.
  3. Close the sensor protection cover.
- 
- b. When using the reading locking function, deactivate the function before starting every measurement.

## 5.4 ONE-POINT CALIBRATION

1. To set 'One-point calibration', press and hold the **MEAS** button for 3 seconds. Press the **CAL** button until **CAL** appears.
2. Press the **MEAS** button again for 0.5 seconds and the calibration type will be displayed (1 or 2). Press the **CAL** button to change the setting to 1 as required and press **MEAS** again to apply the setting.



3. Open the protection cover and put some drops of the 1.41 mS/cm standard solution into the measurement cell.

Washing the sensor with standard solution beforehand may provide more accurate calibration.

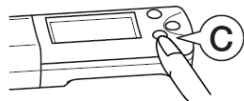

4. Close the protection cover and press the CAL button for over 2 seconds.

**CAL** and ☺ flashes and the calibration value is displayed.

After the calibration is completed, **CAL** and ☺ stop flashing and illuminate constantly.

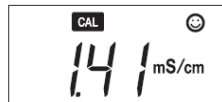

5. Clean the sensor with tap water and remove moisture.
6. Press the MEAS button for 0.5 seconds to enter the measurement mode and prepare for measurement.

## 6 SPECIAL SETTING MODE

The special setting mode enables the meter setting and special operations. To enter the special setting mode, press and hold the **MEAS** button for over 3 seconds in the measurement mode. All the LCD lights illuminate, the meter is now in the special setting mode.

- By continuously pressing the **CAL** button this will change the display sequentially.
- See 6.1 “Measurement unit setting” on page 21.  
Used to select measurement unit.
- See 6.2 “Temperature display mode” on page 22. This mode displays the ambient temperature measured using an internal temperature sensor.

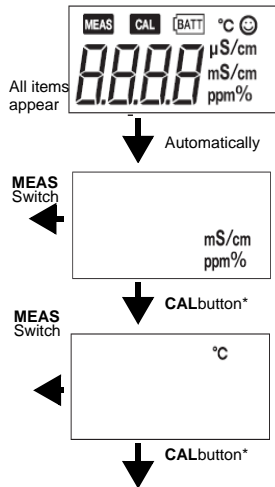

## elcometer®

- See 6.3 “Calibration point setting” on page 23. This mode is used to select the calibration points.
- See 6.4 “Initialisation mode” on page 24. Use this mode to reset the factory default values for all settings and calibration data.
- See 6.5 “Software version display mode” on page 25. This mode displays the current software version.

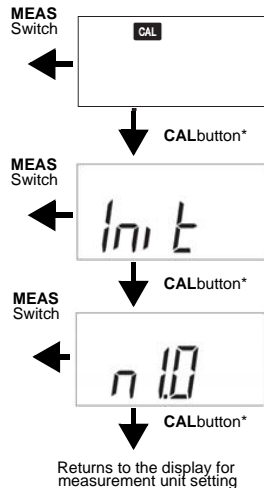

**Note:** To exit the special setting mode with no setting change, press the **ON/OFF** button to turn **OFF** and **ON** again.

## 6.1 MEASUREMENT UNIT SETTING

Used to select measurement unit.

1. Press and hold the **MEAS** button for over 3 seconds in the measurement mode to enter the special setting mode.

All items appear on the LCD and then the display changes as shown.

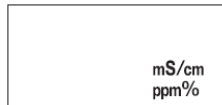

2. Press the **MEAS** button for 0.5 seconds. The current setting is displayed.
3. Press the **CAL** button for 0.5 seconds to change the setting. Pressing the **CAL** button continuously changes the settings sequentially.

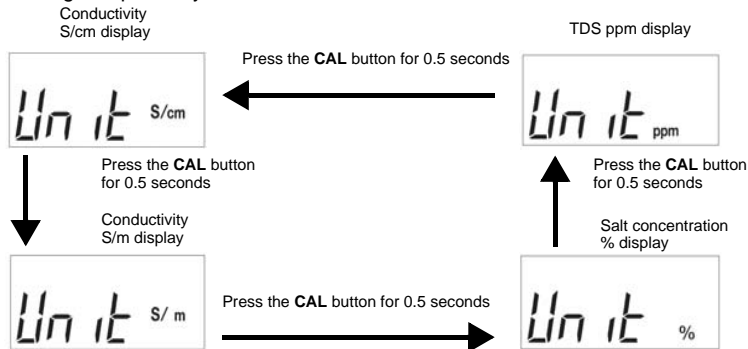

4. Press the **MEAS** button to apply the setting. The instrument is returned to measurement mode.

## 6.2 TEMPERATURE DISPLAY MODE

This mode displays the ambient temperature measured with the internal temperature sensor. The measurement accuracy is indeterminate. Use the value only as a guide.

1. Press and hold the **MEAS** button for over 3 seconds in the measurement mode to enter the special setting mode.

All modes appear on the LCD and then the display changes as shown on the right.

2. Press the **CAL** button until °C is displayed.
3. Press the **MEAS** button for 0.5 seconds. The ambient temperature measured using an internal temperature sensor is displayed.
4. Press the **MEAS** button to return to the measurement mode.

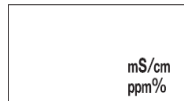



### 6.3 CALIBRATION POINT SETTING

Used to select the calibration points.

1. Press and hold the **MEAS** button for over 3 seconds in the measurement mode to enter the special setting mode.

All modes appear on the LCD and then the display changes as shown on the right.

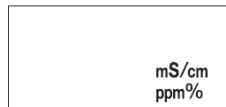

2. Press the **CAL** button until **CAL** is displayed.
3. Press the **MEAS** button for 0.5 seconds. The current setting is displayed.



4. Press the **CAL** button for 0.5 seconds to change the setting.

#### One-point calibration



Press the **CAL** button for 0.5 seconds



#### Two-point calibration



5. Press the **MEAS** button to apply the setting. The instrument will be returned to measurement mode.

## 6.4 INITIALISATION MODE

All settings and all calibration data are reset to the factory default values.

1. Press and hold the **MEAS** button for over 3 seconds in the measurement mode to enter the special setting mode.

All modes appear on the LCD and then the display changes as shown on the right.

2. Press the **CAL** button until **Init** is displayed.

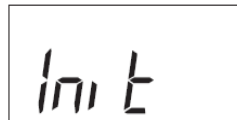
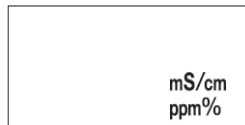

3. Press the **MEAS** button for 0.5 seconds. 😊 is displayed.

4. Press the **CAL** button for over 2 seconds. All settings and all calibration data are reset to the factory default values.

Initialisation is complete when **End** and 😊 are displayed.

5. Press the **ON/OFF** button to turn **OFF** and **ON** again.

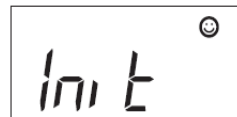

## 6.5 SOFTWARE VERSION DISPLAY MODE

1. Press and hold the **MEAS** button for over 3 seconds in the measurement mode to enter the special setting mode.

All modes appear on the LCD and then the display changes as shown on the right.

2. Press the **CAL** button until **Init** is displayed.
3. Press the **CAL** button for 0.5 seconds. The software version is displayed.

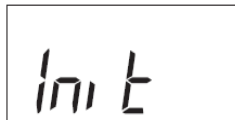
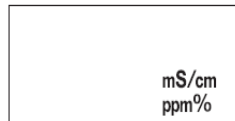

## 7 MAINTENANCE

---

The Elcometer 138 Conductivity Meter is designed to give many years reliable service under normal operating and storage conditions.

### 7.1 CARE OF THE CONDUCTIVITY METER SENSOR

- Prolonged periods of non-use may cause the sensor to dry out. This can result in malfunction or unstable readings. Pour moistening solution into the sensor cell and leave for a few minutes to allow the sensor to become saturated. Wash the sensor with water prior to use.
- If the measuring surface of the sensor is contaminated or if air bubbles are regularly present in the sample, clean the sensor using a diluted neutral detergent (diluted 100 times).

### 7.2 FAULTS

The Elcometer 138 Conductivity Meter does not contain any user-serviceable components. In the unlikely event of a fault, the Elcometer 138 Conductivity Meter should be returned to your local Elcometer supplier or directly to Elcometer. The warranty will be invalidated if the instrument has been open.

Contact details can be found at [www.elcometer.com](http://www.elcometer.com).

## 8 STORAGE

---



The Elcometer 138 Conductivity Meter incorporates a Liquid Crystal Display. If the display is heated above 50°C (120°F) it may be damaged. This can happen if the Elcometer 138 Conductivity Meter is left in a car parked in strong sunlight.

**Note:** *If the meter is to remain unused for a long period of time use purified (deionised) water instead of tap water.*

## 9 TECHNICAL SPECIFICATION

---

Measurement principle:	2 AC bipolar method						
Measurement mode:	Conductivity/sodium chloride (NaCl) salinity conversion/TDS (Total Dissolved Solids) conversion						
Measurement ranges and Accuracy:	<table style="border-left: 1px solid black; border-right: 1px solid black; border-collapse: collapse;"> <tr> <td style="border: none; padding: 0 10px;">0</td> <td style="border: none;">-199 <math>\mu\text{S/cm} \pm 5 \mu\text{S/cm}</math></td> </tr> <tr> <td style="border: none; padding: 0 10px;">0.2</td> <td style="border: none;">-1.99 <math>\text{mS/cm} \pm 0.05 \text{mS/cm}</math></td> </tr> <tr> <td style="border: none; padding: 0 10px;">2</td> <td style="border: none;">-19.9 <math>\text{mS/cm} \pm 0.5 \text{mS/cm}</math></td> </tr> </table>	0	-199 $\mu\text{S/cm} \pm 5 \mu\text{S/cm}$	0.2	-1.99 $\text{mS/cm} \pm 0.05 \text{mS/cm}$	2	-19.9 $\text{mS/cm} \pm 0.5 \text{mS/cm}$
0	-199 $\mu\text{S/cm} \pm 5 \mu\text{S/cm}$						
0.2	-1.99 $\text{mS/cm} \pm 0.05 \text{mS/cm}$						
2	-19.9 $\text{mS/cm} \pm 0.5 \text{mS/cm}$						
Display:	Liquid Crystal Display (LCD) 2½ digits						
Measurement temperature:	5°C to 40°C (41°F to 105°F)						
Dimensions:	164 mm x 29 mm x 20 mm (6.5" x 1.1" x 0.79")						
Weight (incl. dry batteries):	47 g (1.7 oz)						
Case:	ABS						
Battery Type:	2 x CR2032 lithium						

### 9.1 CARRYING CASE

Overall Case Dimensions:	345 mm x 290 mm x 85 mm (13.6" x 11.4" x 3.3")
Weight:	1.1 kg (2 lb 7 oz)
Material:	Polypropylene foam-lined with cutouts for Bresle Patches, Water, Conductivity Meter and accessories

## 10 SPARE PARTS AND ACCESSORIES

---

The Elcometer 138 Conductivity Meter is complete with all the items required to get started and take measurements, however over the life of the instruments spares and accessories may be required. The following items are available from Elcometer, or your local supplier.

### 10.1 CONSUMABLE ITEMS

Calibration solution 1.41 mS/cm, 6x14ml	T13823926
Calibration solution 12.9 mS/cm, 6x14ml	T13824404
Pure water, 250 ml	T99911344

### 10.2 REPLACEMENT ITEMS

Elcometer 138 Conductivity Meter	T13823925
Sensor for conductivity meter	T13823928

## 11 RELATED EQUIPMENT

---

In addition to the Elcometer 138 Bresle Kit and Patches, Elcometer produces a wide range of other equipment for testing and measuring the characteristics of coatings. Users of the Elcometer 138 may also benefit from the following Elcometer products:

- Elcometer 134A Chloride Ion Test Kit for Abrasives
- Elcometer 134S Salt Detection Kit for Blast Cleaned Surfaces
- Elcometer 134W Chloride Ion Test Kit for Water/Liquids
- Elcometer 130 Salt Contamination Meter

For further information contact Elcometer, your local supplier or visit [www.elcometer.com](http://www.elcometer.com).